



# PEFY-P25VMM-E

Indoor Unit

Ceiling Concealed Ducted



The PEFY-P-VMM-E ducted indoor unit is concealed within the ceiling space to allow unobtrusive air conditioning. Flexibility of duct layout allows airflow patterns to be arranged to suit any application.

- **Reduced noise levels thanks to the use of a newly designed centrifugal fan, as low as 27dBA**
- **Drain lift-pump (option), 550mm of lift**
- **Complete flexibility in air conditioning design**
- **Cooling operation set temperature can be set down to 14°C db when used with R410A**

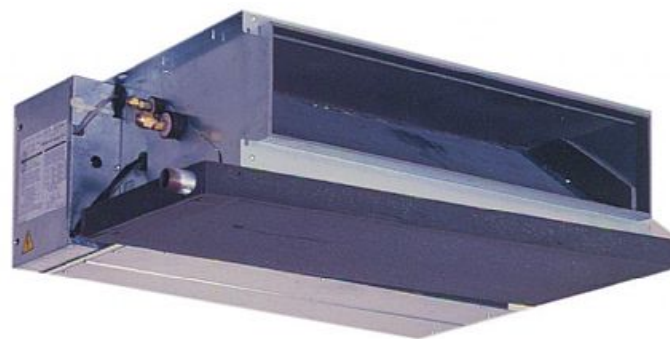

Pictures not to scale

## Product Details

PEFY-P25VMM-E	
Capacity (kW):	
Heating (Nominal)	3.2
Cooling (Nominal)	2.8
R410A Heating (UK)	3.0
R407c Heating (UK)	3.0
R410A Cooling (UK)	2.6
R407c Cooling (UK)	2.7
R410A High Sensible Cooling (UK)	2.0
SHF R410A (UK)	0.77
SHF R407c (UK)	0.74
SHF High Sensible R410A (UK)	0.85
Power Input (kW) Heating (Nominal)	0.15
Power Input (kW) Cooling (Nominal)	0.15
Airflow (m3/min) - Lo-Mi-Hi	6-7.2-8.5
External Static Pressure Pa - Lo-Mi-Hi	30-50-100
Noise (dBA) - Lo-Mi-Hi	27-30-32
Width - mm	815
Depth - mm	700
Height - mm	295
Weight - kg	27
Electrical Supply	220-240v, 50Hz
Phase	Single
Mains Cable No. Cores	3
Running Current (A) - Heating	0.73
Running Current (A) - Cooling	0.73
Fuse Rating (BS88) - HRC (A)	6

## Dimensions

PEFY-P25VMM-E

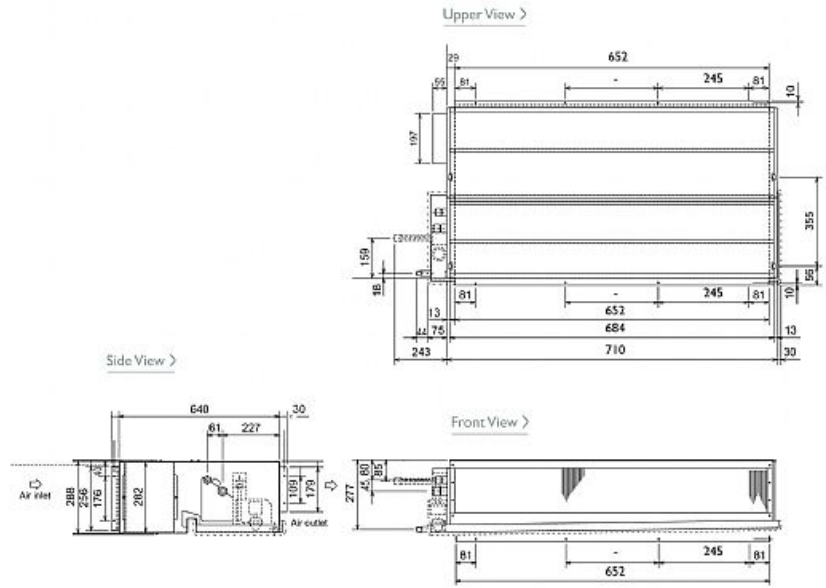

Telephone: 01707 282880

Email: [air.conditioning@meuk.mee.com](mailto:air.conditioning@meuk.mee.com) Website: <http://www.mitsubishielectric.co.uk/aircon>

Mitsubishi Electric reserves the right to make any variation in technical specification to the equipment described, or to withdraw or replace products without prior notification or public announcement.

Tel:  
Fax:

